



Einbauanleitung Automatic-Antennen

Montagehandleiding van
Automatische antennes

Installation instructions
Automatic-Antennas

Instructions de montage
Antennes automatiques

HIT AUTA 2040

Bestell-Nr. / Bestel-nr. / Ord. code / N° de cde.

921 738-001

HIT AUTA 2040 SW

Bestell-Nr. / Bestel-nr. / Ord. code / N° de cde.

921 738-002

Betriebsspannung 9 ... 16 VDC
Bedrijfsspanning 9 ... 16 VDC
Operating voltage 9 ... 16 VDC
Tension de service 9 ... 16 VDC

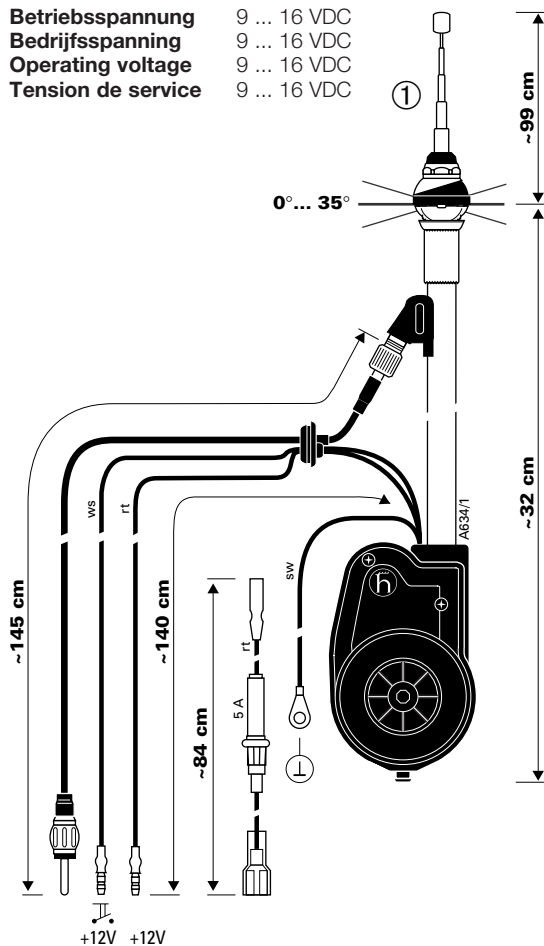

Leitungsfarben / Draadkleure /
Leads colour / Couleurs de conduites
rt: rot / rood / red / rouge
sw: schwarz / zwart / black / noir
ws: weiß / wit / white / blanc

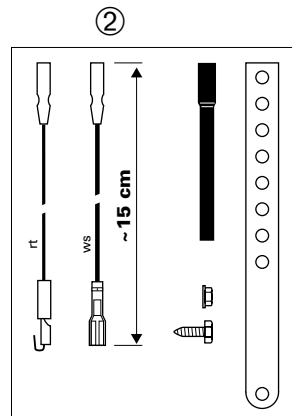

Lieferumfang

- ① Antenne mit Antennenkopf
0 ... 35°, HF-Kabel, elektrische
Leitungen und Kabeltülle
- ② Zubehör:
Schlauch, M5-Schraube, Mutter,
Adapterkabel, Halter

Samenstelling

- ① Antenne met antennekop
0 ... 35°, HF-kabel, elektrische
leidingen, kabelplug
- ② Toebehoren:
slang, M5-schroef, moer,
adapterkabel, houder

Scope of delivery

- ① Automatic antenna with anten-
na base 0 ... 35°, HF-cable,
electric cables and cable sleeve
- ② Accessories:
drain tube, M5-screw, nut,
adapter cable, bracket

Gamme de livraison

- ① Antenne automatique avec tête
d'antenne 0 ... 35°, le câble HF,
cables électriques et le passe-
câble
- ② Accessoires:
tuyau, vis M5, écrou,
câble adaptateur, support

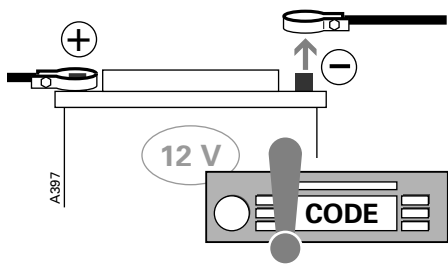

Fig.1

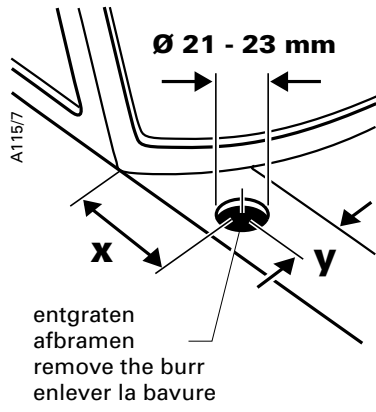

Fig.2

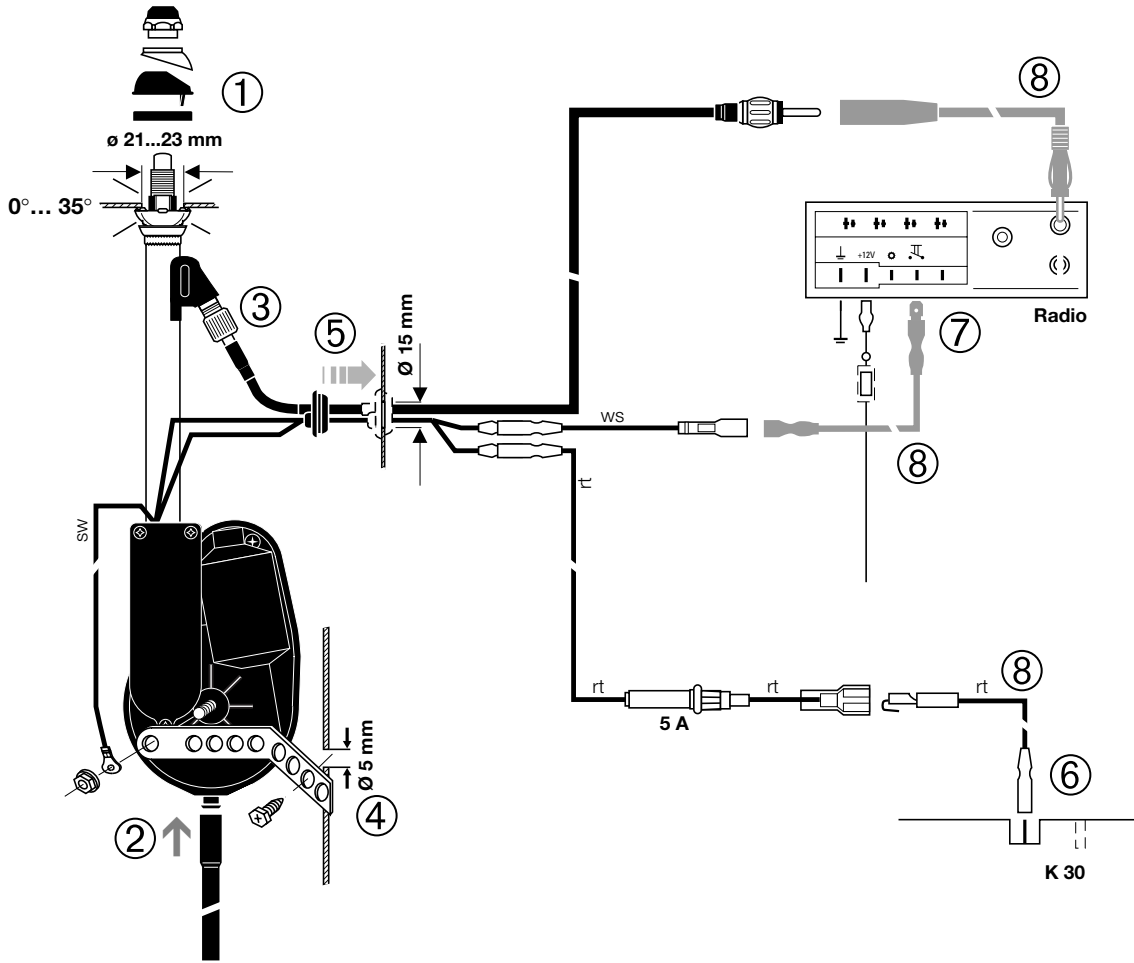

Fig.3

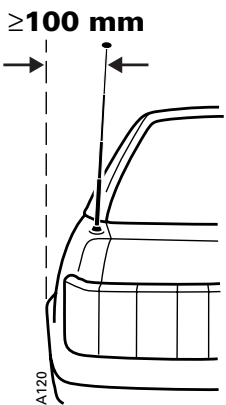

Fig.4

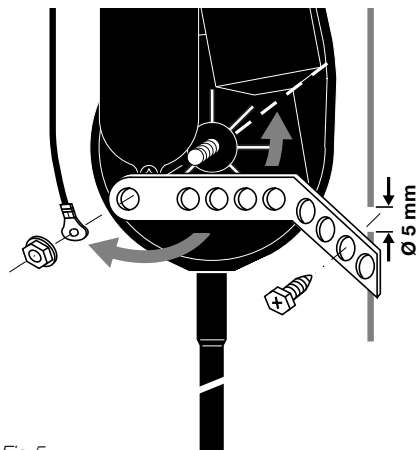
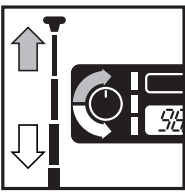

Fig.5



Automatic-Antenne:
Radio einschalten - Antenne fährt aus.
Radio ausschalten - Antenne fährt ein.

Automatische antenne:
Radio aanzetten - antenne komt naar buiten.
Radio uitzetten - antenne gaat naar binnen.

Automatic Antenna:
Switch radio on - antenna will extend.
Switch radio off - antenna will retract.

Antenne automatique:
Mettre en marche la radio - l'antenne sort.
Arrêter la radio - l'antenne rentre.

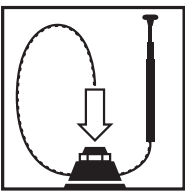

Einfacher Teleskopwechsel ohne Ausbau der Antenne möglich.
Ersatzteleskope für
HIT AUTA 2040: Bestell-Nr. 823 674-001
HIT AUTA 2040 SW: Bestell-Nr. 823 674-002

Simpele telescoopwissel zonder uitbouwen van de antenne mogelijk.
Vervangingstelescopen voor
HIT AUTA 2040: Bestelnr. 823 674-001
HIT AUTA 2040 SW: Bestelnr. 823 674-002

Easy telescope exchange possible without antenna removal.
Spare telescopes for:
HIT AUTA 2040: Ord. code 823 674-001
HIT AUTA 2040 SW: Ord. code 823 674-002

Possibilité d'échanger simplement le télescope sans démonter l'antenne.
Télescope de rechange:
HIT AUTA 2040: N° de cde. 823 674-001
HIT AUTA 2040 SW: N° de cde. 823 674-002

D

Antenneneinbau

Die Antenne wird nur für Fahrzeuge mit 12 V Batteriespannung geliefert, wobei Minus am Chassis liegen muß.

Die Antenne ist vorwiegend zum Einbau im vorderen Kotflügel bestimmt.
Für den Fronteinbau muß im Schwenkbereich der Vorderräder genügend Platz für den Antrieb vorhanden sein. Für den Heckeinbau ist auf genügend Platz hinter dem Radlauf im Kofferraum zu achten.
Für den Heckeinbau steht der Verlängerungskabelsatz HIT AUKAB 420 (Best.-Nr. 820 640-001) zur Verfügung (Fig. 3, ⑧).

Für einige Fahrzeugtypen finden Sie den Einbauvorschlag in der nachfolgenden Übersicht.

Zur Sicherheit die Verbindung zum Batterie-Minuspol abklemmen; dazu Anweisung des Fahrzeug-Herstellers beachten (Fig. 1).

An der Einbaustelle ein Loch mit \varnothing 21 mm einarbeiten. Die Neigung der Karosserie kann dabei bis 35° betragen (Fig. 2).

Das Karosserieblech auf der Unterseite um die Bohrung herum blank machen und mit Kontaktschutzfett bestreichen. Dadurch wird eine gute Masseverbindung für die Abschirmung und Schutz vor Korrosion erreicht.

Von der Antenne die oberen Antennenkopf-teile abnehmen (Fig. 3, ①). Den Kunststoffschlauch am Antriebsgehäuse aufstecken (Fig. 3, ②).

Das Antennenkabel am Antennenstutzen handfest nachziehen (Fig. 3, ③).

Die Antenne von unten in die Karosserie einsetzen. Die Wippe in der Schale auf dem Distanzring so drehen, daß sie rund um die Bohrung anliegt (Fig. 3, ①).

Die Halbkugel mit der Dichtunterlage von oben durch die Bohrung einführen und in die auf der Unterseite anliegende Wippe einfügen (Fig. 3, ①).

Die Halbschale und die Mutter aufsetzen. Die Mutter leicht anziehen (Fig. 3, ①).

Die Antenne ausfahren und das Teleskop ausrichten (Fig. 4). Zum Ausfahren die rote (rt) und weiße (ws) Leitung mit dem Plus-, die schwarze Leitung (sw) mit dem Minuspol der 12 V Batterie verbinden.

Den Haltebügel entsprechend biegen, am Antriebsgehäuse festschrauben und mit der Blechschraube an der inneren Karosserie bzw. einer Verstrebung befestigen (Fig. 3, ④ und Fig. 5).

Die Mutter am Antennenkopf anziehen (Anzugsmoment max. 4 Nm).

HF-Kabel, rote und weiße Motoranschlußleitung in den Innenraum verlegen.

Karosseriedurchführung für Kabeltülle bohren (\varnothing 15 mm) und zur Abdichtung die Kabeltülle einsetzen (Fig. 3, ⑤).

Die Leitungen wie folgt anschließen:

► **Schwarze Leitung** (sw) an Minuspol (Fahrzeugmasse) anschließen, z.B. unter Schraube am Halter (Fig. 3, ④ und Fig. 5).

► **Rote Leitung** (rt) mit Kabelsicherung (5A) an einer direkt zum Batterie-Pluspol geschalteten Leitung, z.B. an Klemme 30 an den Wagensicherungen oder am Lichtschalter, aufstecken.

► **Weißer Steuerleitung** (ws) und das Antennenkabel zum Autoradio-Einbauort verlegen und einstecken. Sofern am Autoradio ein entsprechender Anschlußkontakt für Automatic-Antennen vorhanden, die beiliegende Flachsteckhülse 2,8-1 aufquetschen (Fig. 3, ⑦).

Nach Beendigung der Installation Batterie wieder anklammern. Bei richtigem Anschluß fährt die Antenne aus, wenn das Autoradio eingeschaltet – wieder ein, wenn das Autoradio ausgeschaltet wird.

Zum Einbau entfernte Verkleidungen wieder einbauen.

Pflegehinweise

Reinigen Sie bitte das Teleskop möglichst oft von anhaftendem Staub und Schmutz. Verwenden Sie nur ganz wenig von unserem Spezialfett in Tuben AUTA 235 oder benutzen Sie unser Autoantennen-Pflegeöl AUTA 135, das gleichzeitig reinigt und fettet. Nach der Reinigung nicht vergessen: das Teleskop abschließend mit einem sauberen Lappen trockenwischen, sonst könnte sich auf der zurückbleibenden überschüssigen Fettschicht um so schneller wieder Schmutz festsetzen.

Ein beschädigtes Teleskop kann von außen am Fahrzeug gewechselt werden. Entsprechende Anleitungen liegen den Ersatzteleskopen bei.

Für:
HIT AUTA 2040: Bestell-Nr. 823 674-001
HIT AUTA 2040 SW: Bestell-Nr. 823 674-002

Technische Änderungen vorbehalten.

Dieses Produkt ist nach seiner Verwendung entsprechend den aktuellen Entsorgungsvorschriften Ihres Landkreises / Landes / Staates als Elektronikschrott einer geordneten Entsorgung zuzuführen.

Die beschriebenen Leistungsmerkmale sind nur dann verbindlich, wenn sie bei Vertragsabschluss ausdrücklich vereinbart wurden. Diese Druckschrift wurde von Hirschmann Electronics GmbH auf Übereinstimmung mit den beschriebenen Antennen und Antennenzubehör (Kabel, Stecker etc.) geprüft. Dennoch können Abweichungen hinsichtlich der Richtigkeit oder Genauigkeit nicht ausgeschlossen werden, sodass Hirschmann für die vollständige Übereinstimmung keine Gewähr übernimmt. Hirschmann behält sich das Recht vor, den Inhalt dieser Druckschrift ohne Ankündigung zu ändern.

Inbouw antenne

De antenne wordt alleen voor voertuigen met 12 V accuspanning geleverd waarbij de minpool aan het chassis moet zitten.

De antenne is voornamelijk bestemd voor inbouw in het voorspatbord.

Voor de inbouw voor moet in het draaibereik van de voorwielen genoeg plaats beschikbaar zijn voor de aandrijving. Voor inbouw achterin moet op voldoende plaats achter de wielloop in de kofferruimte gelet worden.

Voor inbouw achter is de verlengkabelset HIT AUKAB 420 (best.nr. 820 640-001) verkrijgbaar (fig. 3, ⑧).

Voor sommige voertuigtypen staat een inbouw-suggestie in het volgende overzicht.

Voor de veiligheid de verbinding naar de minpool van de accu afklemmen, daarbij letten op de aanwijzingen van de fabrikant! (fig.1).

Op de plaats van inbouw een gat van Ø 21 mm maken. De helling van de carrosserie kan daarbij 35° bedragen (fig. 2).

Het carrosseriemetaal aan de onderkant rondom het gat blank maken en met contactbeschermingsvet insmeren. Daardoor wordt een goede hechting voor afscherming en bescherming tegen roest bereikt.

De bovenste antennekopdelen van de antenne afhalen (fig. 3, ①). De plastic slang op het aandrijfhuis steken (fig. 3, ②).

De antennekabel op het antenneaansluitstuk met de hand aantrekken. (fig. 3, ③).

De antenne van onderen af in de carrosserie plaatsen. De kanteltoets in de schaal zo op de afstandsring draaien dat hij rondom de boring ligt. (fig. 3, ①).

De halve bol met het afdichtingsdeel van boven door het gat in de aan de onderzijde liggende kanteltoets plaatsen (fig. 3, ①).

De halve bol en de moer er opzetten. De moer licht aandraaien (fig. 3, ①).

De antenne uittrekken en de telescoop afstellen (fig. 4). Voor het uittrekken de rode (rt) en witte (ws) leiding met de plus-, de zwarte (sw) leiding met de minpool van de 12 V accu verbinden.

De bevestigingsbeugel voldoende buigen, op het aandrijfhuis vastschroeven en met de plaatschroef aan de binnenkant van de carrosserie c.q. aan een stut vastmaken. (fig. 3, ④ en fig. 5).

De moer aan de antennekop aantrekken (Aandraai moment max. 4 Nm).

HF-kabel, rode en witte motoraansluitingsleiding naar het interieur leggen.

Carrosseriedoorvoer voor kabelmondstuk boren (Ø 15 mm) en als afdichting het kabelmondstuk er zetten. (fig. 3, ⑤).

De kabels als volgt aansluiten:

► De **zwarte** draad (sw) aan de minpool (voertuigmassa) aansluiten, bijv. onder de schroef op de houder (fig. 3, ④ en fig. 5).

► **Rode** leiding (rt) met kabelzekering (5A) aan een direct op de pluspool van de batterij geschakelde leiding, bijv. aan klem 30 op de voertuigzekeringen of aan de lichtschakelaar steken.

► **Witte** besturingsleiding (ws) en de antennekabel naar de autoradio leggen en vaststeken.

Voor zover aan de autoradio een aansluitingscontact voor automatische antennes aanwezig is, de bijgevoegde platte steekhuls 2,8-1 er aan vastmaken (fig. 3, ⑦).

Na de installatie de accu weer vastklemmen. Bij de juiste aansluiting komt de antenne naar buiten als de autoradio wordt aangezet - en gaat weer naar binnen als de autoradio wordt uitgezet.

De voor de inbouw verwijderde bekleding weer aanbrengen.

Onderhoudsaanwijzingen

Haal zo vaak mogelijk stof en vuil van de telescoop af. Gebruik slecht heel weinig van ons speciaal vet in tube AUTA 235 of gebruik onze onderhoudsdoekje voor autoantennes AUTA 135, dat tegelijk reinigt en invet. Na het schoonmaken niet vergeten de telescoop aansluitend met een schone lap droog te wrijven, anders kan op de achterblijvende, overtollige vetlaag des te sneller weer vuil aanheven.

Een beschadigde telescoop kan vanaf de buitenkant van het voertuig vervangen worden. Zie daarvoor de bij de telescoop bijgesloten aanwijzingen.

Voor:
HIT AUTA 2040: Bestelnr. 823 674-001
HIT AUTA 2040 SW: Bestelnr. 823 674-002

Technische veranderingen voorbehouden.

Dit produkt dient na gebruik, conform de milieuvoorschriften van uw land, als elektronica afval verwerkt te worden.

De informatie in deze brochure bevat algemene beschrijvingen of prestatiefactoren, die, wanneer concreet toegepast, niet altijd overeenkomen met de beschreven vorm en aangepast kunnen zijn door verdere ontwikkeling van de producten.

De gewenste beschrijvingen of prestatiefactoren zijn alleen dan bindend wanneer deze uitdrukkelijk overeengekomen zijn tijdens het sluiten van het contract.

Antenna installation

This antenna is available only for cars operated by 12 VDC battery voltage and with battery Minus connected to the car body.

The antenna is mainly designed for the installation in the front fender.

When mounting the antenna in front, enough space must be available for the antenna drive within the swivel area of the front wheels. For rear mounting enough space in the boot behind the wheel box must be considered. For rear installation the extension cable set HIT AUKAB 420 (Ord. code 820 640-001) is available (fig. 3, ⑧).

The installation recommendations for some car types you can find in the following table pages.

Disconnect battery minus for security, according to the instructions of the manufacturer of the cars (fig.1).

Drill a Ø 21 mm dia. hole in the car body at the installation point. At that spot the inclination of the car body must not exceed 35° (fig. 2).

Please bare the body sheet underneath around the hole and cover it with protecting grease. Thus a satisfactory ground connection for the aerial cable screening and protection against corrosion is ensured.

Remove the upper parts from the antenna (fig. 3, ①). Put on the drain tube to the motor housing (fig. 3, ②).

Tighten the antenna cable at the neckpart manually (fig. 3, ③).

Insert the antenna from underneath into the hole. Please see that the lower spherical half has full contact around the hole (fig. 3, ①).

Slide the sealing washer and the upper spherical half over the telescope and take care the upper spherical half coincides with the lower spherical half (fig. 3, ①).

Put on the adapting cover and the hexagonal nut. Tighten the hexagonal nut slightly (fig. 3, ①).

Drive out the telescope and adjust the antenna to the desired direction and inclination (fig. 4). For driving out the red (rt) and white cable (ws) must be connected to plus and the black cable (sw) to minus of the 12 V battery.

If necessary bend the bracket, screw it to the motor housing of the antenna by use of the splash shield or a brace (fig. 3, ④ and fig. 5).

Tighten now the hexagonal nut by means of a socket wrench (Torque max 4 Nm).

Pass the HF-cable, the red and white motor cables to the inside of the car.

Drill a hole into the car body for the grommet (Ø 15 mm) and insert the grommet for sealing (fig. 3, ⑤).

Connecting the cables:

► Connect the **black cable** (sw) to minus (ground), e.g. under screw at the bracket (fig. 3, ④ and fig. 5).

► Connect the **red cable** (rt) to a terminal having a direct lead to battery plus (5 A fuse, e.g. clamp 30 at the car fuses or at the light switch).

► Pass the **white control cable** (ws) and the antenna cable to the installation place of the car radio and connect them. If there is a suitable terminal for connecting automatic antennas, use the enclosed flat receptacle 2,8-1 for crimp termination (fig. 3, ⑦).

After completion of installation reconnect battery. If connected properly, the antenna extends when switching on the radio and retracts when switching off.

Replace linings being removed for installation.

Maintenance

Please clean the telescope as often as possible of adhering dust and dirt. Use only a little of our special grease AUTA 235 supplied in tubes or our car antenna tissue AUTA 135 for both cleaning and greasing.

After cleaning don't forget, finally, to rub dry the telescope with a clean cloth, otherwise some dirt could gather all the quick to remaining grease.

A damage telescope can be exchanged from outside. Suitable instructions are enclosed with the spare telescopes.

For:

HIT AUTA 2040: Ord. code. 823 674-001
HIT AUTA 2040 SW: Ord. code. 823 674-002

Right of modification reserved.

After its use, this product has to be processed as electronic scrap to a proper disposal according to the prevailing waste disposal regulations of your community / district / country / state.

The performance features described here are binding only if they have been expressly guaranteed in the contract. This publication has been created by Hirschmann Electronics GmbH according to the best of our knowledge. Hirschmann reserves the right to change the contents of this manual without prior notice. Hirschmann can give no guarantee in respect of the correctness or accuracy of the details in this publication.

Installation de l'antenne

L'antenne n'est disponible que pour des véhicules avec une tension de batterie de 12 V, supposé que le pôle négatif se trouve au châssis.

L'antenne est prévue pour montage surtout sur l'aile avant.

Pour cela, il faut s'assurer qu'il y ait suffisamment de place pour le moteur sous l'aile en la gamme de pivotement des roues. Pour montage arrière il faut s'assurer qu'il y ait l'espace dans le coffre, après les roues.

Veillez utiliser le câble de rallongement HIT AUKAB 420 (N° de cde. 820 640-001) pour montage arrière (fig. 3, ⑧).

Pour quelques types de véhicule vous trouverez notre proposition de montage dans le tableau suivant.

Pour des raisons de sécurité, débrancher le pôle négatif de la batterie, selon les données du constructeur des véhicules (fig. 1).

Percer à l'endroit prévu pour le montage de l'antenne (cet endroit pouvant être incliné à 35° maxi.) un orifice de 21 mm de diamètre (fig. 2).

Sur la face intérieure de la carrosserie, mettez la tôle à blanc autour du perçage et prenez soin de l'enduire impeccablement de la graisse de contact. Vous assurez ainsi à la fois un parfait contact de masse pour le blindage et une protection anti-corrosive efficace.

Enlever les pièces supérieures de la tête d'antenne (fig. 3, ①). Mettez en place le tuyau sur le boîtier du moteur (fig. 3, ②).

Visser le câble au fût de l'antenne à la main (Fig. 3, ③).

Introduisez l'antenne par le bas dans orifice de la carrosserie et tournez la pièce basculante dans son logement jusqu'à ce qu'elle épouse parfaitement sur l'anneau de distance la paroi intérieure de l'orifice (fig. 3, ①).

Mettre en place, par le haut, la demi-sphère et le joint et ajustez-les, à travers l'orifice, à la pièce basculante (fig. 3, ①).

Glisser la demi-coquille et l'écrou sur l'antenne et serrez légèrement (fig. 3, ①).

Déployer le télescope et orientez-le de sorte qu'il ait direction et l'inclinaison voulues (fig. 4). Relier pour cela les câbles rouge (rt) et blanc (ws) au pôle positif et le câble noir (sw) au pôle négatif de la batterie 12 V et mettez le boîtier à la masse.

Plier le support en fonction de l'endroit de fixation et vissez-la sur le boîtier. Fixer l'autre bout de la bride avec la vis Parker sur la partie intérieure de la carrosserie ou sur un renfort (fig. 3, ④ et fig. 5).

Serrer à fond l'écrou sur la tête de l'antenne (couple de serrage max. 4 Nm).

Posez les câbles HF et d'alimentation (rouge et blanc) à l'intérieur de la voiture.

Percez un trou de Ø 15 mm pour le passage des câbles et mettez en place le passe-câbles pour assurer l'étanchéité (fig. 3, ⑤).

Brancher les conduites comme suit:

► Brancher la **conduite noire** (sw) au pôle négatif (masse véhicule), p.e. sous la vis du support (fig. 3, ④ et fig. 5).

► Fixer la **conduite rouge** (rt) avec fusible de câble (5A) à une conduite branchée directement au pôle positif de la batterie, p.e. à la borne 30

aux fusibles de la voiture ou à l'interrupteur des feus.

► Poser et connecter la **conduite de commande blanche** (ws) et le câble d'antenne à l'endroit du montage de l'autoradio. Sertir la douille plate 2,8-1 jointe, si un contact de branchement correspondant à l'autoradio pour l'antenne automatique exist (fig. 3, ⑦).

Une fois finie l'installation, rébrancher la batterie. Si l'antenne est correctement raccordée, elle sortira quand l'autoradio est mise en marche, et elle rentrera quand la radio est arrêtée.

Remonter les revêtements enlevés pour l'installation.

Conseils d'entretien

Veillez nettoyer le télescope le plus souvent possible de la poussière adhérente et de la saleté. N'utilisez que très peu de notre graisse spéciale en tube AUTA 235 ou bien notre essuie-antenne AUTA 135 qui nettoie et graisse en même temps.

Après avoir nettoyer, n'oubliez pas alors d'essuyer le télescope avec un chiffon propre, sinon la saleté se ramasserait plus vite sur le surplus de couche de graisse.

Un télescope endommagé peut être changé de l'extérieur au véhicule. Des notices correspondantes se trouvent jointe aux télescopes de rechange.

Pour:

HIT AUTA 2040: N° de cde. 823 674-001
HIT AUTA 2040 SW: N° de cde. 823 674-002

Sous réserve de modifications techniques.

Ce produit doit être éliminé en tant que déchet électronique conformément au règlement actuel sur l'élimination des déchets de votre département / région / pays.

La société Hirschmann Electronics GmbH ne se porte garante de la véracité des informations techniques que si elles ont été spécifiées de manière expresse à la signature du contrat. Le contenu de ce document a été minutieusement contrôlé afin de s'assurer qu'il corresponde bien aux antennes et accessoires (câbles, connecteurs) décrits. Toutefois, Hirschmann ne peut en aucun cas être tenu responsable de l'exactitude de ces informations. Hirschmann se réserve le droit de modifier sans préavis le contenu de ce document.

Einbauvorschläge

Für die angegebenen Einbaumaße können wir nicht haften. Bitte die Einbauverhältnisse vor dem Einbau überprüfen.

Hinweis:

Bei Umrüstung anstelle einer vorhandenen Antenne muß das Loch für diese Antenne \varnothing 21 mm bis max. \varnothing 23 mm betragen.

Inbouw instructies

Wij kunnen geen verantwoording nemen voor de aangegeven inbouwmaten. Controleer voor het inbouwen de inbouwomstandigheden.

Opmerking:

Bij ombouw van een reeds aanwezige antenne moet het gat voor deze antenne \varnothing 21 mm tot max. \varnothing 23 mm bedragen.

Installation suggestions

We are unable to assume any responsibility for installation measures. Please check them before installing the antenna.

Remark:

When changing an existing antenna to this automatic antenna the barehole must be \varnothing 21 mm to max \varnothing 23 mm.

Propositions de montage

Nous ne pouvons pas assumer la responsabilité des cotes de montage. Prière de vérifier avant le montage.

Remarque:

En cas de échanger l'antenne existante contre cette antenne automatique le perçage de carrosserie doit être entre \varnothing 21 mm - max. \varnothing 23 mm.

Alfa Romeo 164

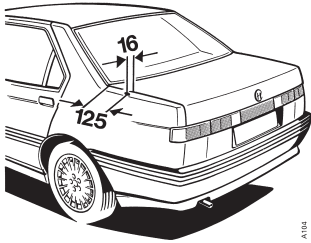

A108

Alfa Romeo 33

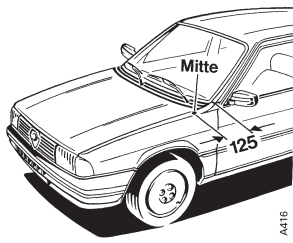

A416

Alfa Romeo 75

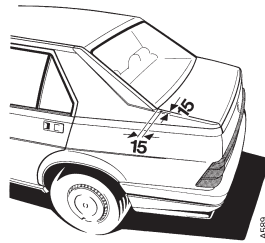

A685

Alfa Romeo 90

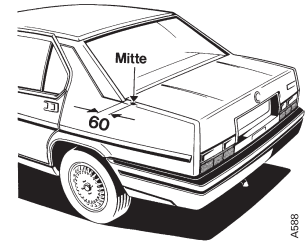

A586

Alfa Romeo GTV Coupé

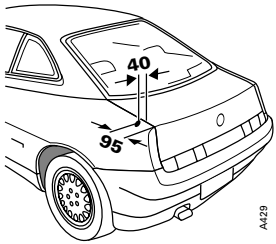

A429

Alfa Romeo GTV Spider

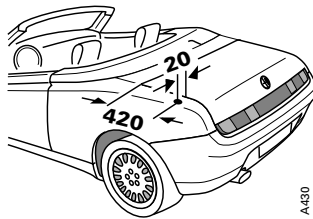

A430

Alfa Romeo Guiletta → 83

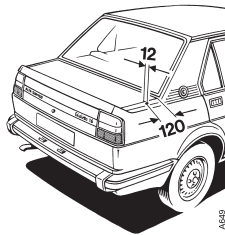

A649

Alfa Romeo Guiletta 84 →

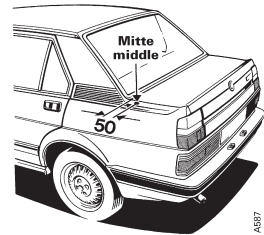

A587

Alfa Romeo Spider Veloce

Bohrung vorhanden/gat aanwezig/hole provided/ perçage existant

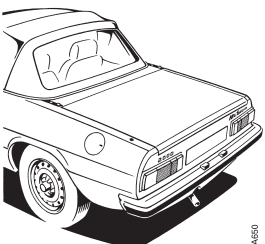

A680

Audi 80 8.78 →

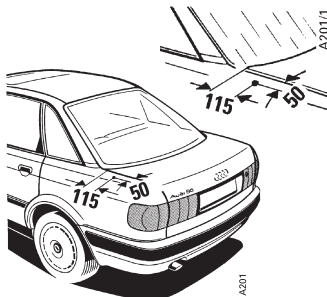

A201

Audi 80 Cabriolet

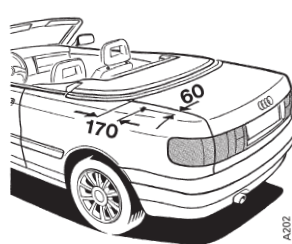

A202

Audi 90 5.87 →

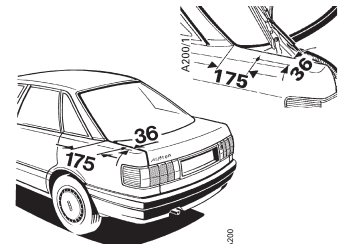

A200

Audi 100 9.82 → 11.90

Audi 200 6.83 →

Audi V 8 → 93

Bohrung vorhanden/gat aanwezig/hole provided/ perçage existant → 2.87

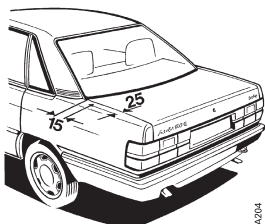

A204

Audi A 4

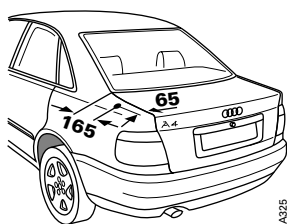

A205

Audi A 6 6.94 →

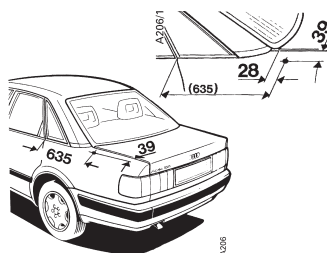

A206

BMW 3.. Limousine 27.11.82 →
Baureihe/serie/series/séries E 30

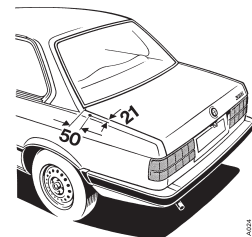

A604

BMW 3.. Cabrio
Baureihe/seerie/series/séries E 30

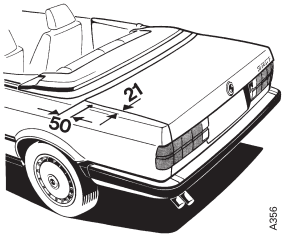

A296

BMW 3.. Limousine 12.90 →
Baureihe/seerie/series/séries E 36
4türig/4-deursmodel/4 doors/4 portières

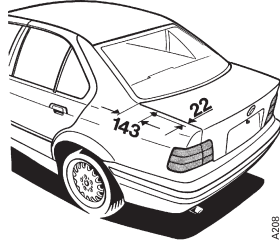

A298

BMW 3.. Compact
Baureihe/seerie/series/séries E36

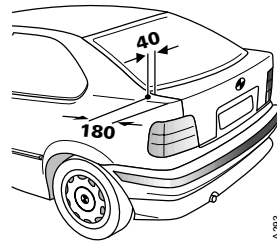

A293

BMW 3.. Coupé
Baureihe/seerie/series/séries E 36,
2türig/2-deursmodel/2 doors/2 portières

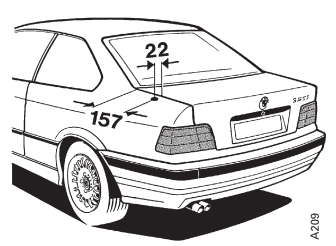

A299

BMW 3.. Cabrio
Baureihe/seerie/series/séries E 36

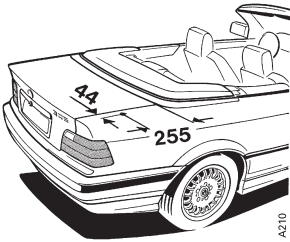

A210

BMW 5.. Limousine → 5.87
Baureihe/seerie/series/séries E 28

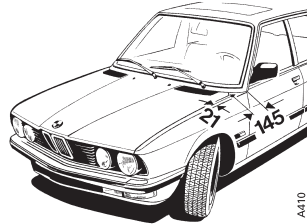

A410

BMW 5.. Limousine 6.81 → 87
Baureihe/seerie/series/séries E 28

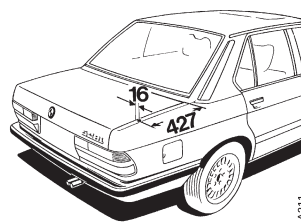

A211

BMW 5.. Limousine 6.87 →
Baureihe/seerie/series/séries E 34

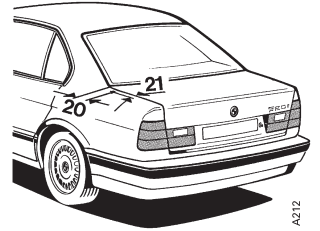

A212

BMW 5.. Touring
Baureihe/seerie/series/séries E 34/2

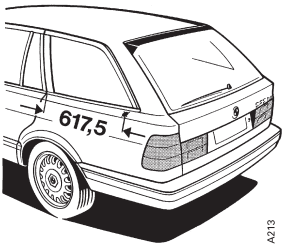

A213

BMW 5.. Limousine 12.95 →
Baureihe/seerie/series/séries E 39

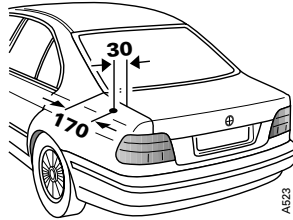

A523

BMW 7.. Limousine → 8.86
Baureihe/seerie/series/séries E 23

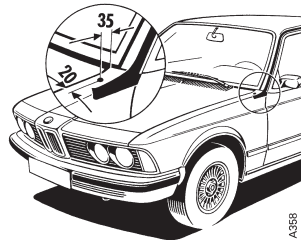

A358

BMW 7.. Limousine → 8.86
Baureihe/seerie/series/séries E 23

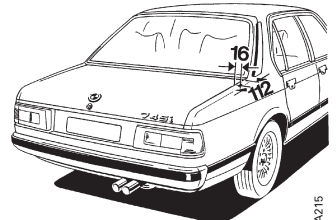

A215

BMW 7.. Limousine 9.86 →
Baureihe/seerie/series/séries E 32

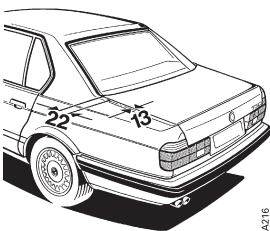

A216

BMW 7.. Limousine 6.94 →
Baureihe/seerie/series/séries E 38

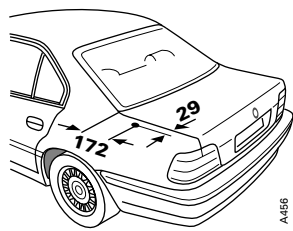

A456

BMW 8.. Coupé
Baureihe/seerie/series/séries E 31

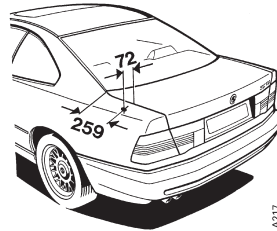

A217

Citroën CX

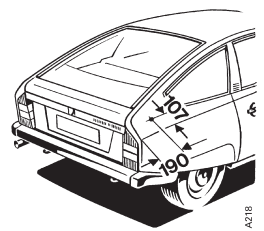

A218

Fiat 131

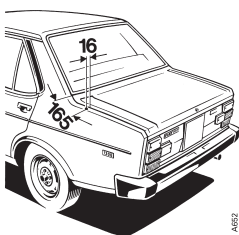

A622

Fiat Mirafiori

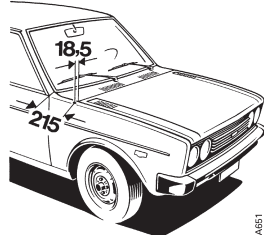

A651

Fiat 132

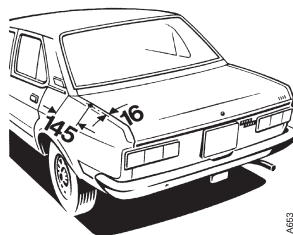

A653

Fiat Argenta

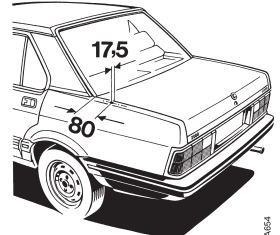

A654

Fiat Barchetta

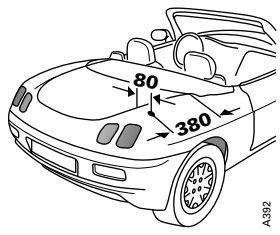

A392

Fiat Cinquecento

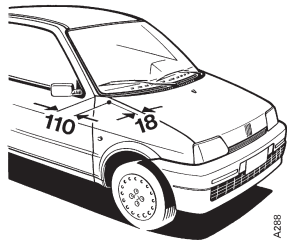

A288

Fiat Regata

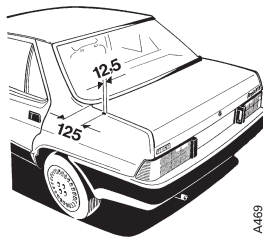

A469

Fiat Ritmo

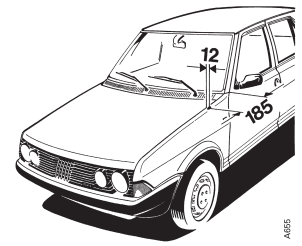

A685

Fiat Spidereuropa

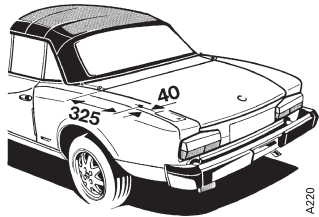

A220

Fiat Uno

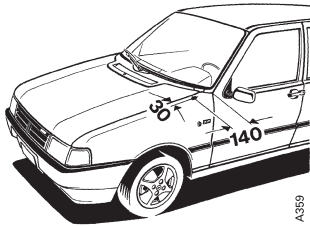

A369

Fiat X 1/9

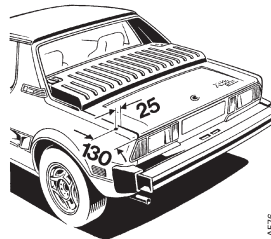

A576

Ford Escort Limousine 8.93 → mit Stufenheck/4 deurs/notchback/4 portes
Ford Orion 9.90 →

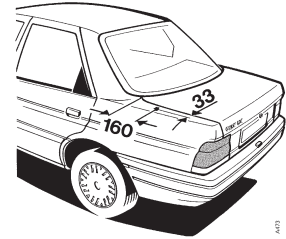

A471

Ford Escort Limousine 9.90 → mit Fließheck/5 deurs/hatchback/arrière en pente

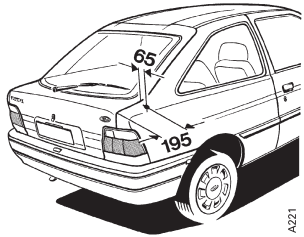

A221

Ford Escort Cabriolet → 8.90

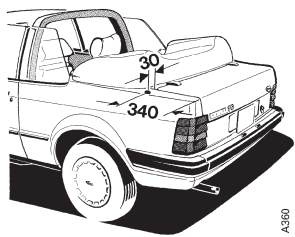

A360

Ford Escort Cabriolet 10.90 →

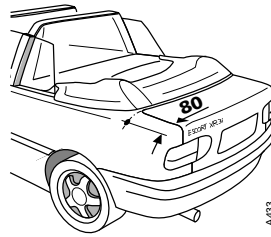

A483

Ford Escort → 8.90
Ford Orion → 8.90

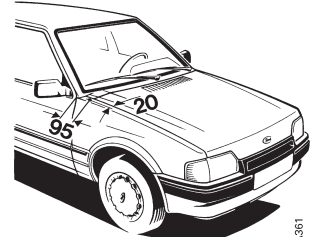

A361

Ford Fiesta → 95

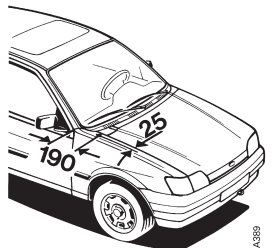

A389

Ford Granada → 4.85

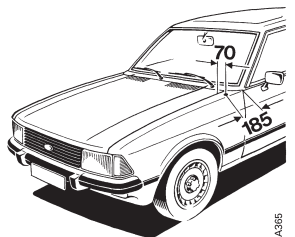

A385

Ford Mondeo Limousine mit Fließheck/5 deurs/hatchback/arrière en pente

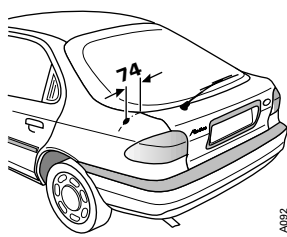

A082

Ford Mondeo Limousine mit Stufenheck/4 deurs/notchback/4 portes

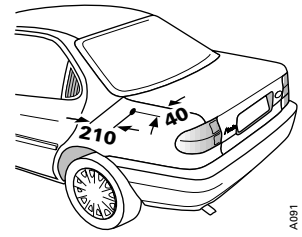

A081

Ford Scorpio Limousine 10.94 →

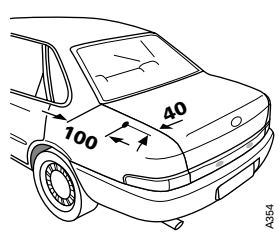

A354

Ford Scorpio Limousine → 9.94 mit Fließheck/5 deurs/hatchback/arrière en pente

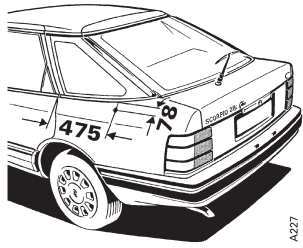

A227

Ford Sierra Limousine mit Fließheck/5 deurs/hatchback/arrière en pente

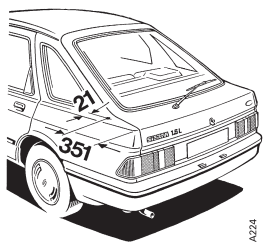

A224

Ford Sierra Limousine mit Stufenheck/4 deurs/notchback/4 portes

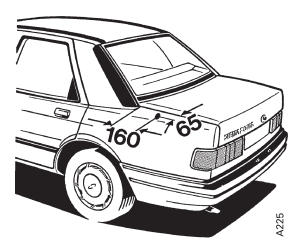

A225

Ford Sierra Limousine/Turnier

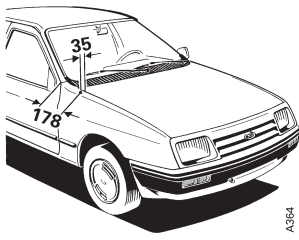

A364

Ford Sierra Turnier

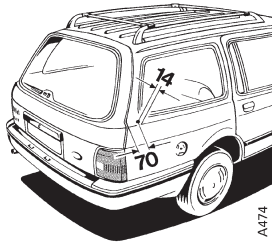

A474

Ford Taunus 80 →

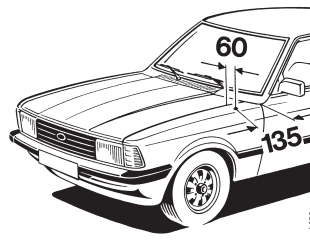

A866

Ford Transit → 85

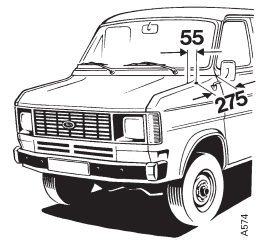

A674

Honda Accord Limousine 7.89 → 92

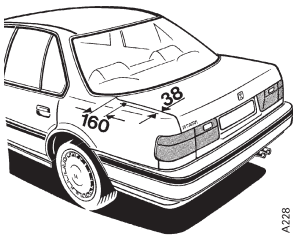

A228

Honda Accord Limousine 93 →

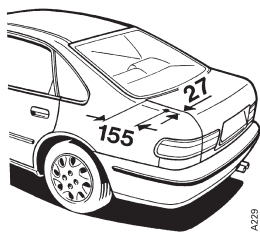

A229

Honda Accord Coupé

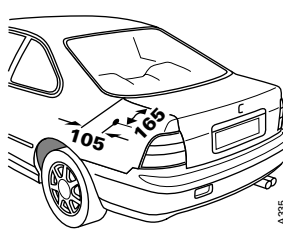

A336

Honda Legend Limousine → 90

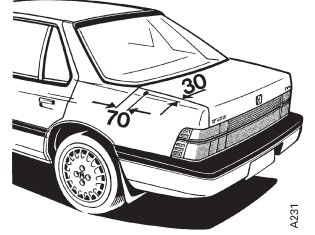

A231

Honda Legend Limousine 91 →

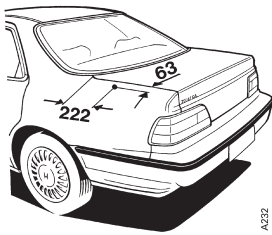

A232

Honda Legend Coupé → 90

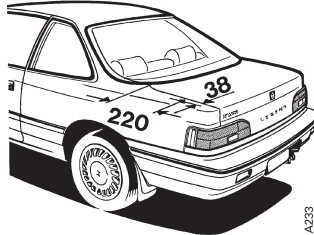

A233

Honda Prelude 9.87 → 8.91

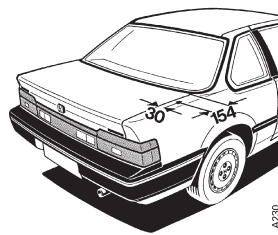

A230

Hyundai Lantra 91 →

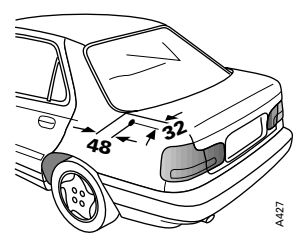

A427

Hyundai Sonata → 4.93

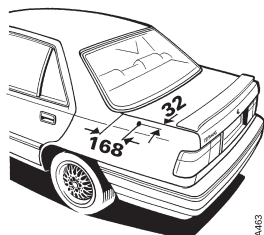

A465

Hyundai Sonata 5.93 →

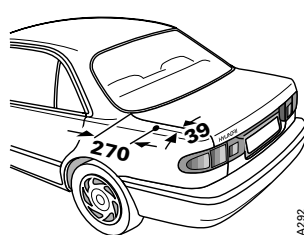

A292

Kia Sephia Limousine mit Stufenheck/4 deurs/notchback/4 portes

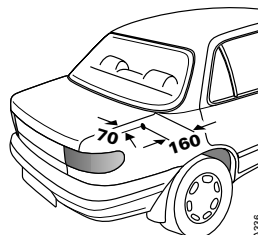

A336

Kia Sephia Limousine mit Fließheck/5 deurs/hatchback/arrière en pente

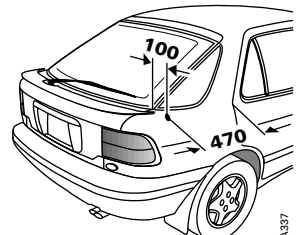

A337

Lancia Beta

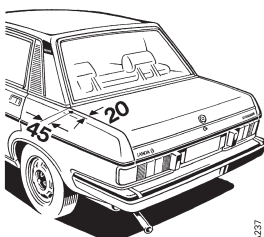

A227

Lancia Dedra

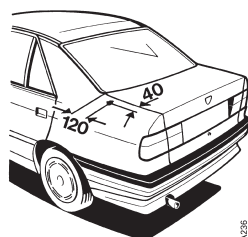

A236

Lancia Delta → 92

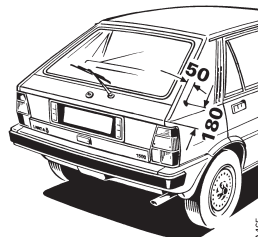

A465

Lancia Prisma

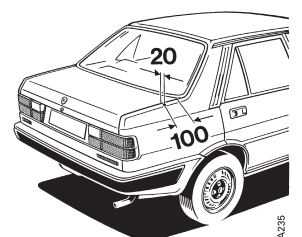

A235

Lancia Thema

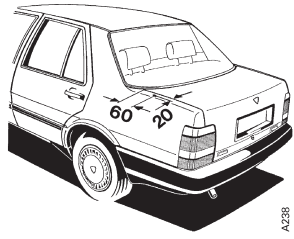

A238

Mazda 323 8.85 →

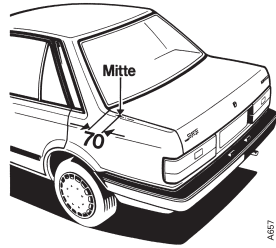

A267

Mazda 323 Limousine 9.94 →
mit Fließheck/5 deurs/hatchback/
arrière en pente

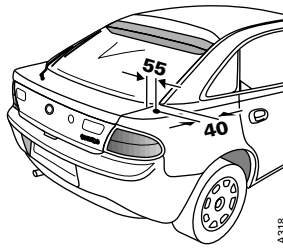

A318

Mazda 323 Limousine 9.94 →
mit Stufenheck/4 deurs/notchback/
4 portes

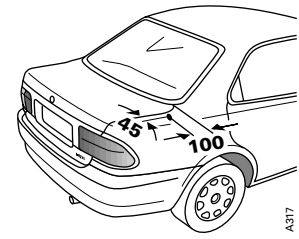

A317

Mazda 626 Limousine 83 →

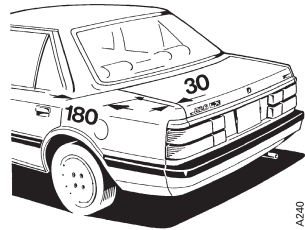

A240

Mazda 626 Limousine 10.87 → 91

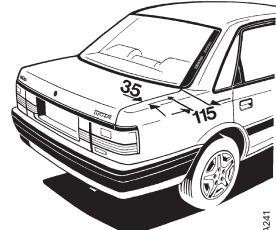

A241

Mazda 626 Liftback 10.87 → 91

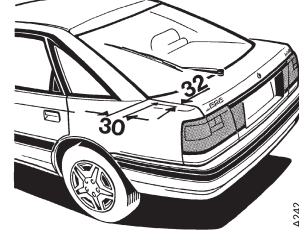

A242

Mazda 626 Coupé 10.87 → 91

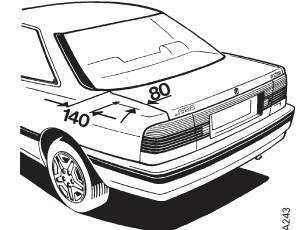

A243

Mazda 929 → 86

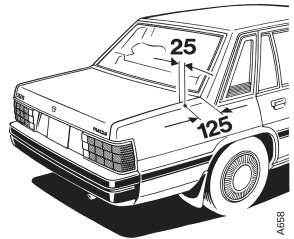

A268

Mazda 929 Limousine 87 →

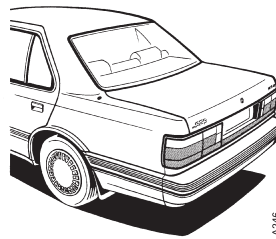

A246

Mazda MX 6

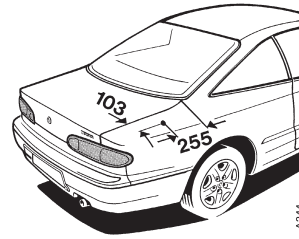

A244

Mazda RX 7 → 85

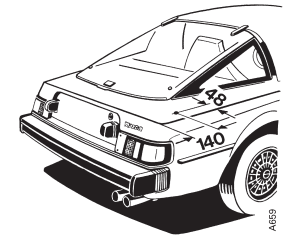

A269

Mazda RX 7 86 → 90

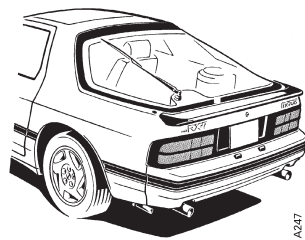

A247

Mazda RX 7 10.91 →

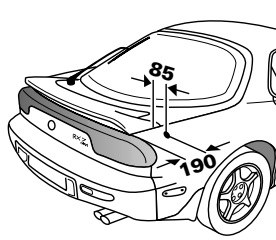

A322

Mazda Xedos 6

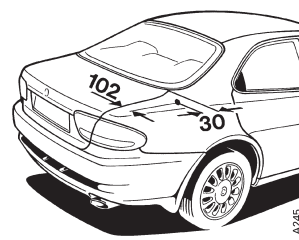

A245

Mazda Xedos 9

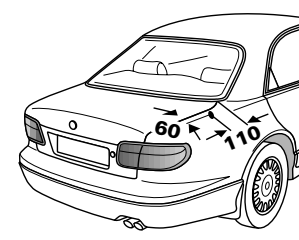

A291

Mercedes 230 G/230 GE/240 GD/
250 GD/300 GD/280 GE

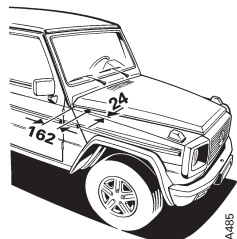

A485

Mercedes 280 SL/300 SL/350 SL/
380 SL/420 SL/450 SL/500 SL 9.76 →
Baureihe/seerie/series/séries R 107

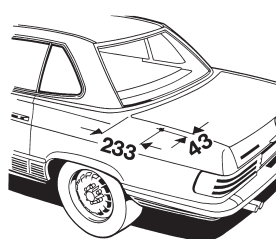

A304

Mercedes 200 - 280 E
Baureihe/seerie/series/séries W 114/115

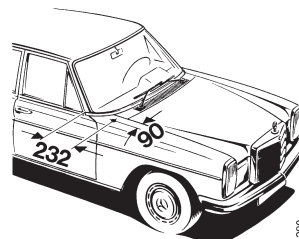

A390

Mercedes 200 - 300D
Limousine + Coupé
Baureihe/seerie/series/séries W 123

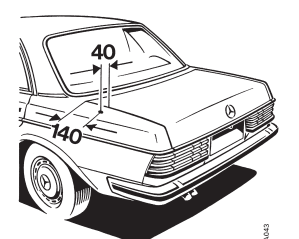

A483

**Mercedes 200 D/220 D/240 D/
240 TD/300 D/300 TD**
Baureihe/seerie/series/séries W 123/S 123

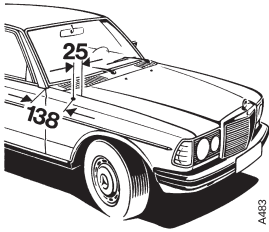

A483

**Mercedes 200/200 D/230 E/250 D/
260 E/300 D/300 E** → 8.88
Baureihe/seerie/series/séries W 124
**Mercedes E-Klasse-Limousinen
E 200 - E 500 (200 - 500 E)** 9.88 →
Baureihe/seerie/series/séries W 124

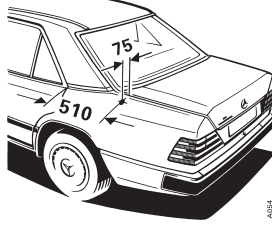

A484

Mercedes 260SE - 560SEL Limousine
Baureihe/seerie/series/séries W 126

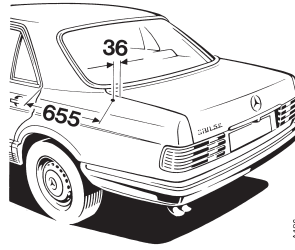

A186

Mercedes 380SEC - 560SEC Coupé
Baureihe/seerie/series/séries C 126

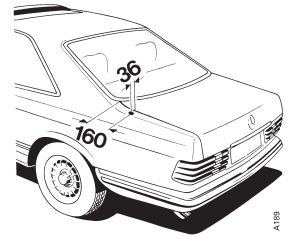

A189

**Mercedes 190/190 D (2,5)/190 E
(2,3/2,6/2,3-16)** → 4.87
Baureihe/seerie/series/séries W 201

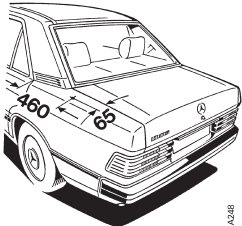

A348

**Mercedes 190/190 D (2,5)/190 E
(1,8/2,0/2,3/2,6/2,3-16/2,5-16)** 5.87 →
Baureihe/seerie/series/séries W 201

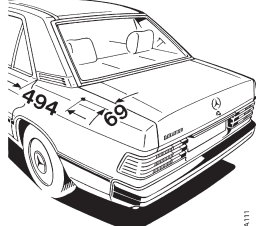

A111

Mitsubishi Galant 88 → 92

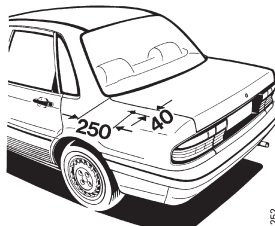

A352

Mitsubishi Galant → 92

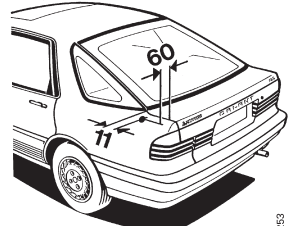

A253

Mitsubishi Lancer 88 → 92

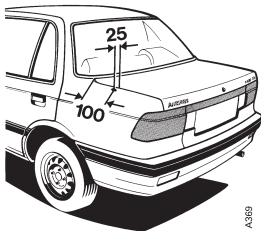

A369

Mitsubishi Pajero → 2.91

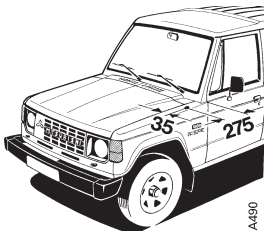

A490

Mitsubishi Sapporo

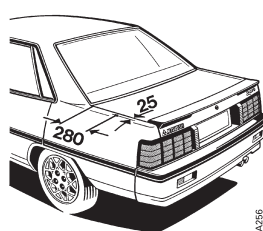

A356

Mitsubishi Sigma

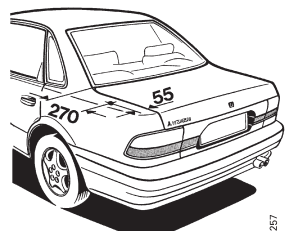

A257

Mitsubishi Tredia

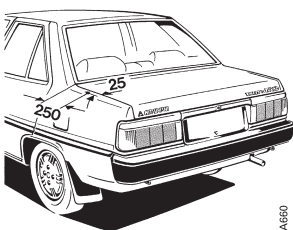

A460

Nissan 200 SX → 93

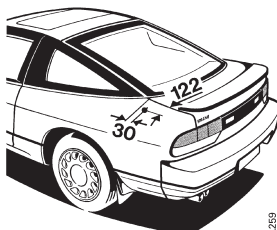

A269

Nissan 200 SX 94 →

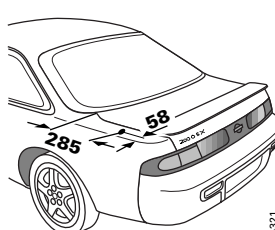

A321

Nissan Bluebird 84 →

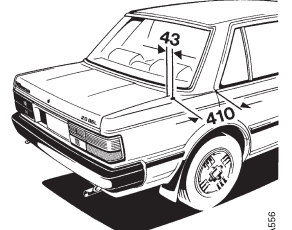

A466

Nissan Laurel

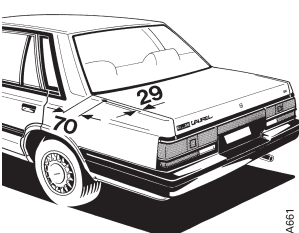

A461

Nissan Maxima → 94

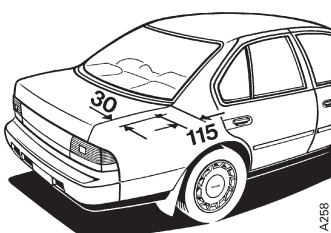

A258

Nissan Primera Kombi

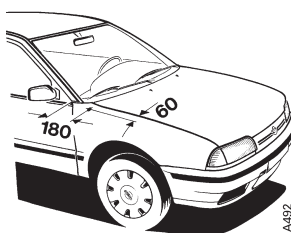

A492

Opel Ascona A, B, C

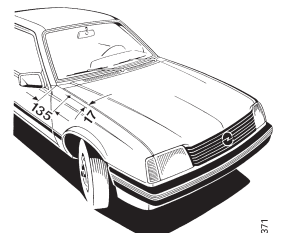

A371

Opel Kadett E
außer/met uitzondering van/
except/excepté GSi 16V

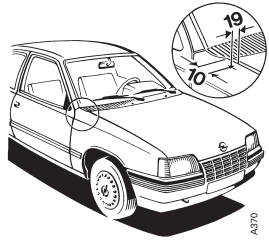

A370

Opel Monza / Rekord

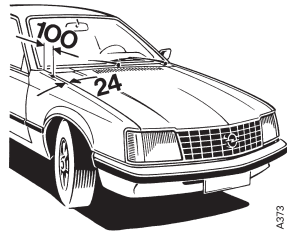

A373

Opel Omega A

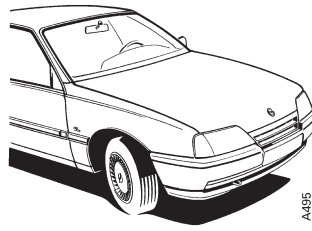

A495

Opel Tigua

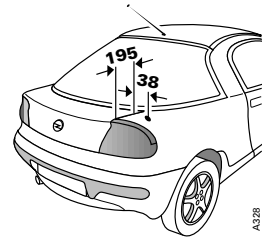

A328

Opel Vectra B 10.95 →

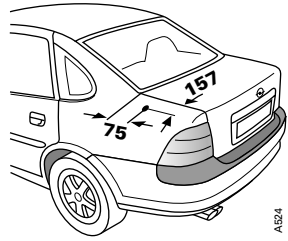

A324

Peugeot 305

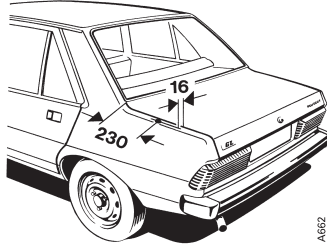

A662

Peugeot 306 Cabriolet

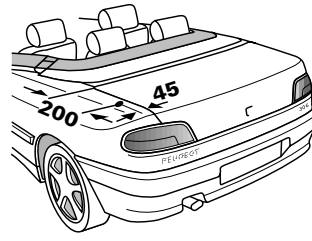

A311

Peugeot 306 Coffre
mit Stufenheck/4 deurs/
notchback/berline

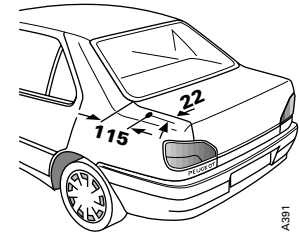

A381

Peugeot 405 Limousine

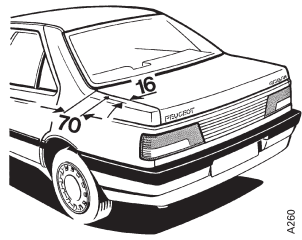

A260

Peugeot 504 Limousine

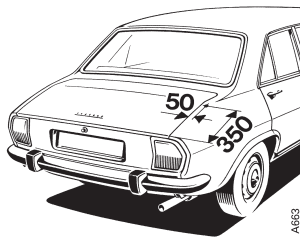

A663

Peugeot 505 Limousine

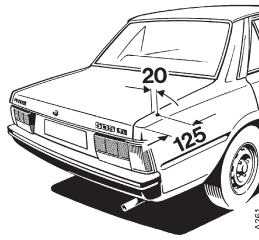

A261

Peugeot 605

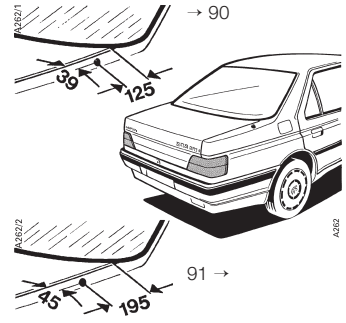

A262

Porsche 911 Carrera 89 → 93
Baureihe/seerie/series/séries 964

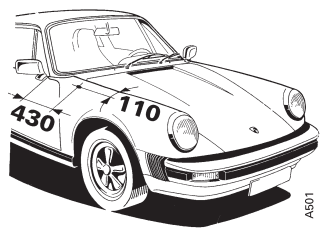

A501

Porsche 911 Carrera 10.93 →
Baureihe/seerie/series/séries 993

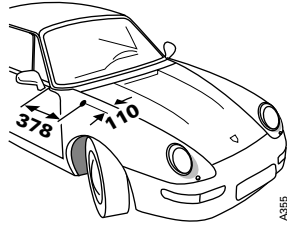

A385

Porsche 924/944

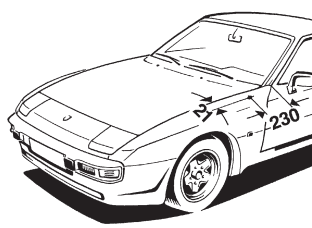

A686

Proton 415/416 Limousine
mit Stufenheck/4 deurs/notchback/
4 portes

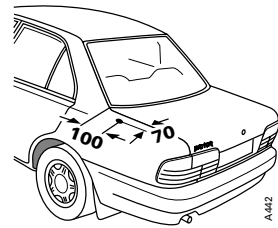

A442

Proton 415/416 Limousine
mit Fließheck/5 deurs/hatchback/
arrière en pente

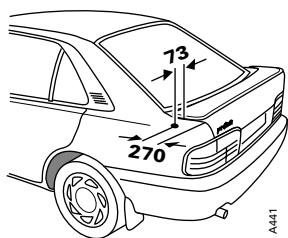

A441

Renault 5 85 →

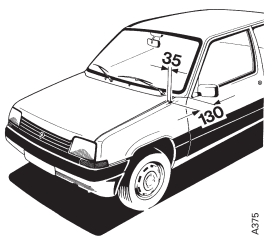

A375

Renault 14



A464

Renault 18

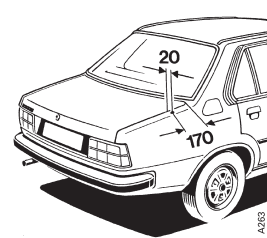

A366

Renault 19 Chamade

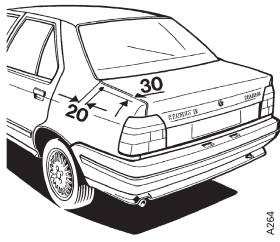

A264

Rover 213/216

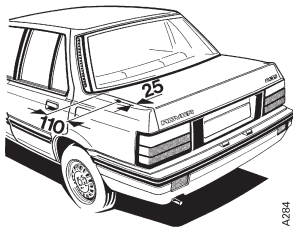

A264

Rover 214/216 Cabriolet

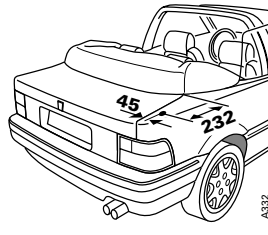

A332

Rover 400 Limousine → 95

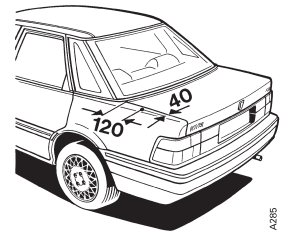

A265

Rover 600 Limousine

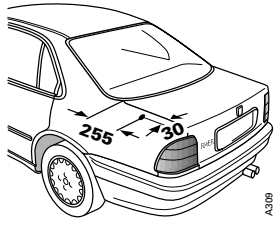

A309

Rover 800 Limousine

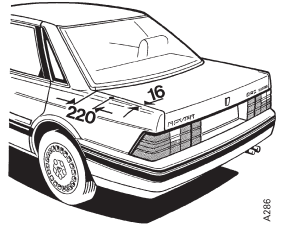

A286

Rover 827 Coupé

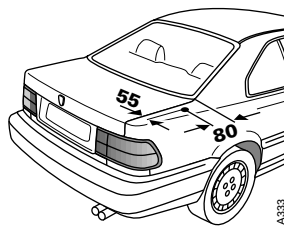

A333

Rover Discovery

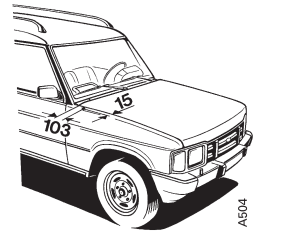

A504

Saab 900 Limousine 8.93 →

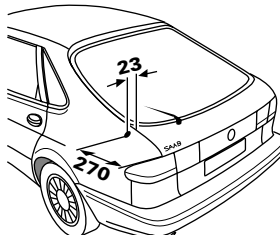

A334

Saab 9000 CD Limousine mit Stufenheck/4 deurs/notchback/4 portes

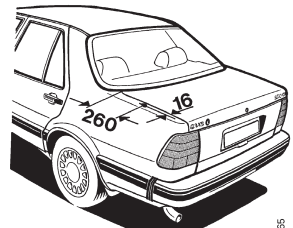

A265

Saab 9000 CS

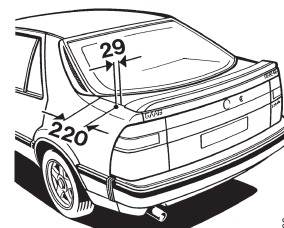

A286

Seat Ibiza → 8.93

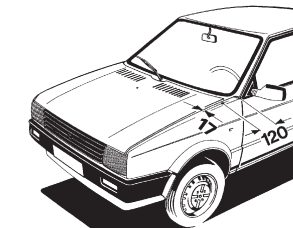

A377/1

Seat Toledo → 8.94 Bohrung vorhanden/gat aanwezig/ hole provided/ perçage existant

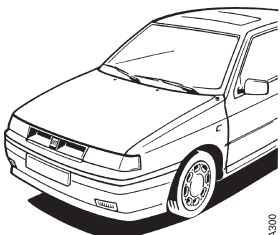

A300

Seat Toledo 9.94 →

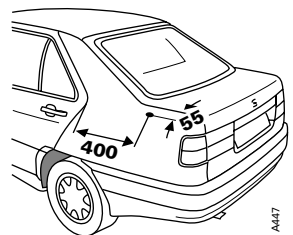

A417

Skoda 105/120/130

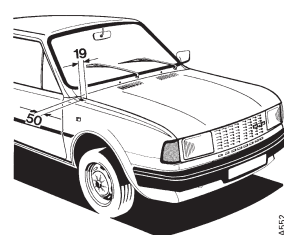

A352

Skoda Favorit / Forman

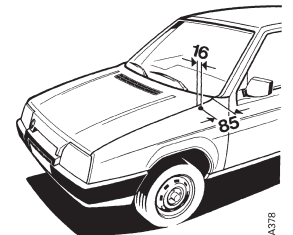

A378

Subaru Impreza Sedan

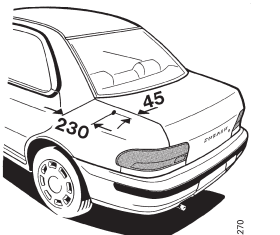

A270

Subaru Legacy Limousine → 93

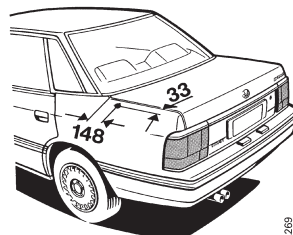

A269

Subaru Legacy Limousine 94 →

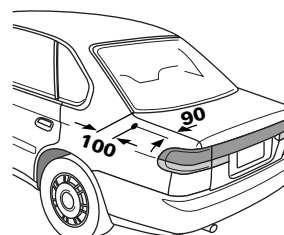

A329

Subaru XT 4WD 85 →

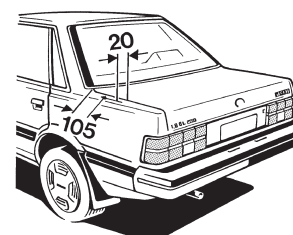

A257

Talbot Horizon

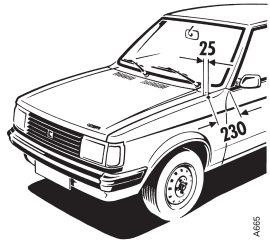

A685

Talbot Tagora

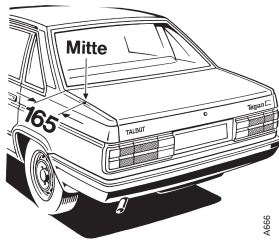

A686

Toyota Camry Limousine 87 → 91

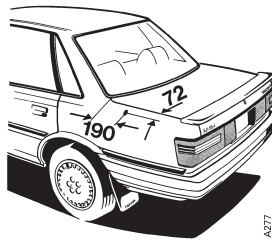

A277

Toyota Camry 9.91 →

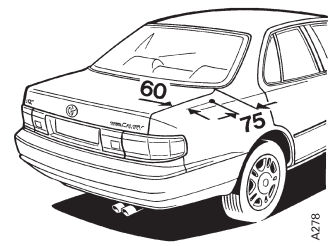

A278

Toyota Carina E Limousine 92 →
mit Stufenheck/4 deurs/
notchback/berline

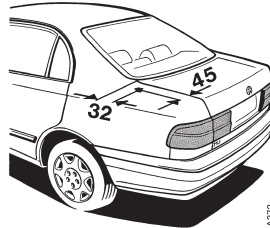

A272

Toyota Carina E Liftback

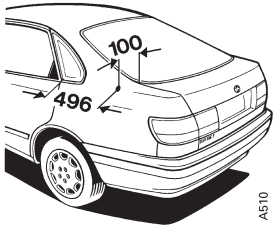

A510

Toyota Celica 90 → 93

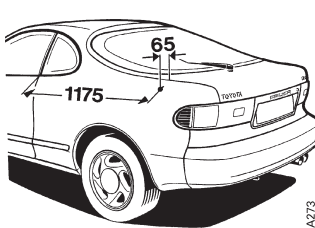

A273

Toyota Celica 94 →

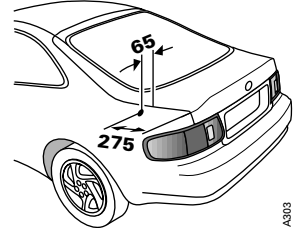

A303

Toyota Corolla Coupé 9.83 → 7.87

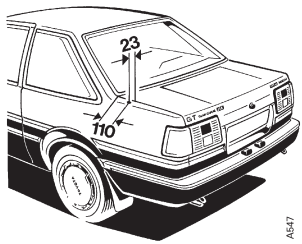

A547

Toyota Corolla Limousine 8.83 → 7.87

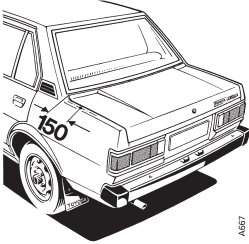

A687

Toyota Cressida 81 →

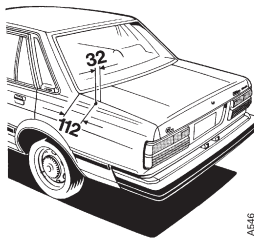

A546

Toyota Crown Combi

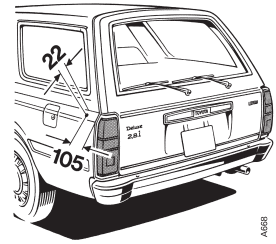

A688

Toyota MR 2

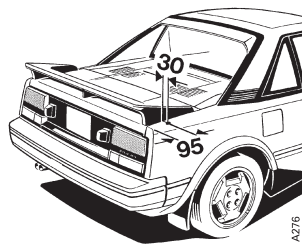

A276

Toyota Supra 86 → 90

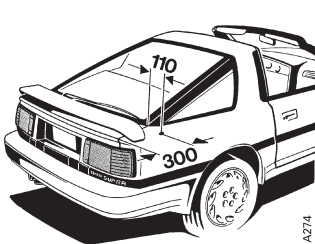

A274

Volvo 240 Limousine 90 →

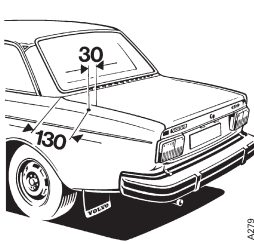

A279

Volvo 440 Limousine
Bohrung vorhanden/gat aanwezig/
hole provided/ perçage existant

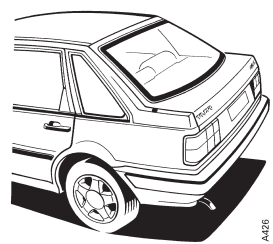

A125

Volvo 460

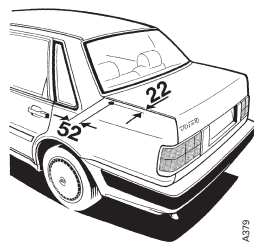

A379

Volvo 850

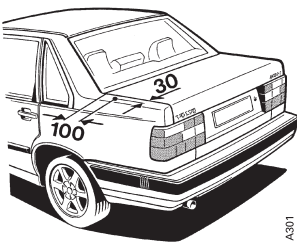

A301

Volvo 940/960 Limousine
Bohrung vorhanden/gat aanwezig/
hole provided/ perçage existant

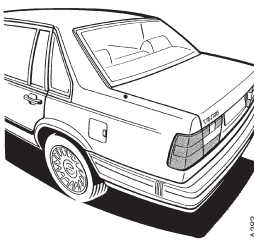

A283

VW Golf I Cabriolet → 8.93
Bohrung vorhanden/gat aanwezig/
hole provided/ perçage existant

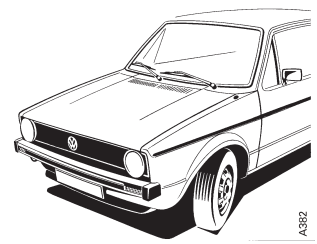

A382

VW Golf II → 8.91
Bohrung vorhanden/gat aanwezig/
hole provided/ perçage existant

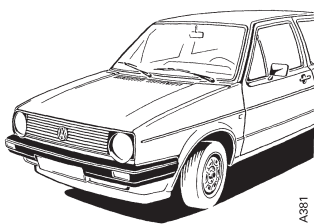

A381

VW Jetta, → 8.91
Bohrung vorhanden/gat aanwezig/
hole provided/ perçage existant

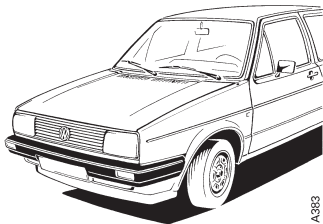

A383

VW Käfer 1303
Bohrung vorhanden/gat aanwezig/
hole provided/ perçage existant

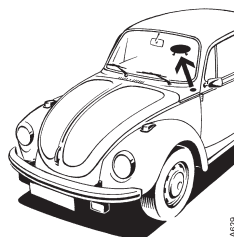

A629

VW Passat Limousine → 3.88
VW Passat Variant → 5.88
Bohrung vorhanden/gat aanwezig/
hole provided/ perçage existant

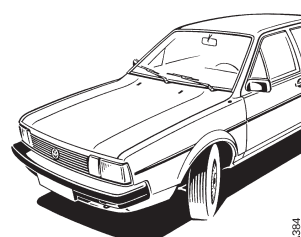

A384

VW Polo 10.94 →
Bohrung vorhanden/gat aanwezig/
hole provided/ perçage existant

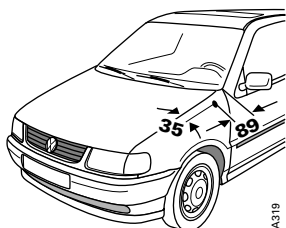

A319

VW Polo / Derby 9.81 → 8.90
Bohrung vorhanden/gat aanwezig/
hole provided/ perçage existant

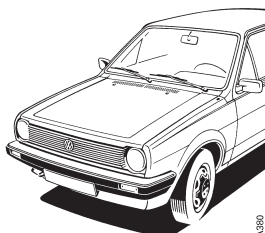

A390

VW Polo 10.90 →
Bohrung vorhanden/gat aanwezig/
hole provided/ perçage existant

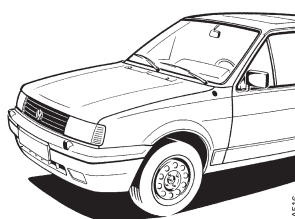

A516

VW Santana
Bohrung vorhanden/gat aanwezig/
hole provided/ perçage existant

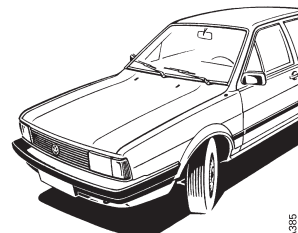

A385

VW Scirocco 5.81 →
Bohrung vorhanden/gat aanwezig/
hole provided/ perçage existant

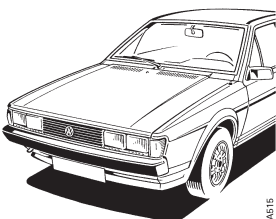

A515

Zubehör / Accessoires / Accessories / Accessoires

	Typ /Type		Bestell-Nr./Bestelnummer/ Ord. code/N° de cde
Verlängerungskabelsatz / Verlengingskabelset / Extension cable set / Set de câble rallonge	HIT AUKAB 420	l = 4,00 m	820 640-001
			
Antennenköpfe / Antennekopen / Antenna heads / Têtes d'antenne	AUTA 8232	32°	822 138-005
	AUTA 8237	37°	822 569-002
	AUTA 8254	54°	821 740-005
	AUTA 8259	59°	822 578-001
	AUTA 8264	64°	821 851-005
	AUTA 8268	68°	823 080-002

D

Hirschmann Electronics GmbH
Car Communication Systems
Stuttgarter Strasse 45 - 51
D-72654 Neckartenzlingen
Tel +49-7127-14-1873
Fax +49-7127-14-1428
E-mail: mktsales@hirschmann.de

NL

Hirschmann Electronics B.V.
Pampuslaan 170
NL-1382 JS Weesp
Tel +31-294-46 25 97
Fax +31-294-48-05 06
E-mail: mkt@hirschmann.nl

F

Hirschmann Electronics S.A.S
2, rue des Charpentiers
F-95330 Domont
Tel +33-1-39 33 44 52
Fax +33-1-39 35 01 02
E-mail: cdeclercq@hirschmann.fr

E

Hirschmann Electronics S.A.
C/Trespaderne, 29
Edificio Barajas 1, 2º Planta
E-28042 Madrid
Tel +34-91-746-1730
Fax +34-91-746-1735
E-mail: hes@hirschmann.es

H

Hirschmann Electronics Kft.
Rokolya u. 1 - 13
H-1131 Budapest
Tel +36-1-349-4199
Fax +36-1-329-8453
E-mail: info@hirschmann.hu

USA

Hirschmann Electronics Inc.
20440 Century Blvd., Suite 150
Germantown, MD 20874
Tel +1-240-686-2300
Fax +1-240-686-3589
E-mail:
ant-sales@hirschmann-usa.com